

## Industrial application

PLASTICS & RUBBER INDUSTRY

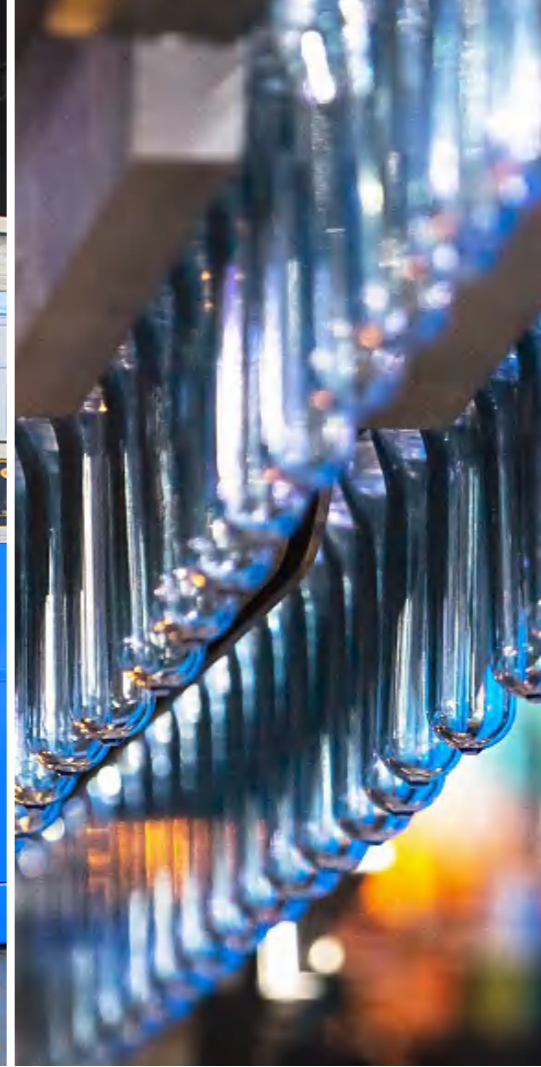

This sample only includes some TBF's products, for more information, please contact us !

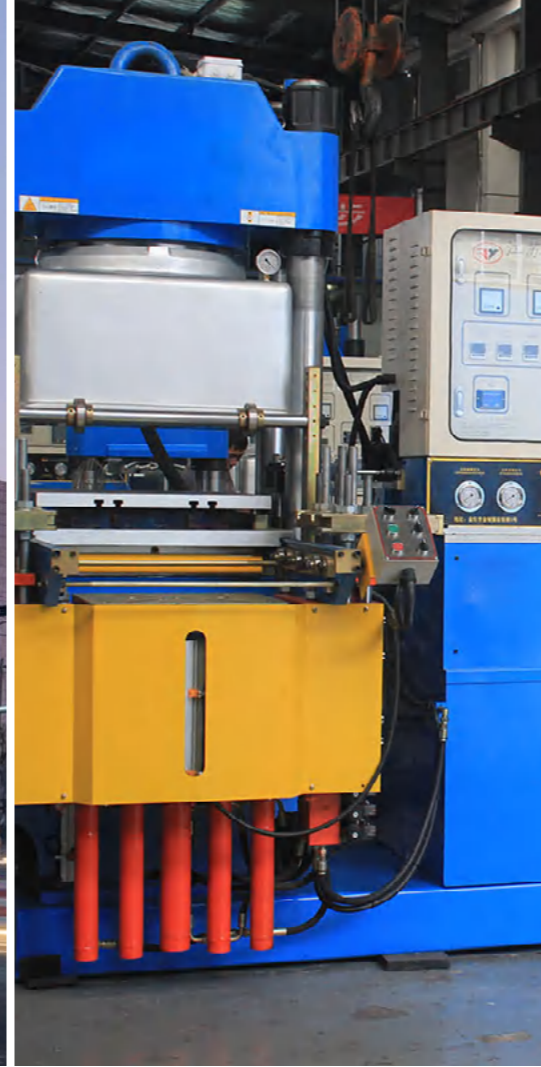

National Specialized Little Giant in Sensor Industry

## QUALIFICATIONS

State-level specialized and innovative "little giant" enterprise Beijing Enterprise Technology Center, a "specialized, refined, special and innovative" enterprise.

156 patents.



## Dedicated to the research and development of sensors and detection technologies



Beijing Tebeifu Electronic Technology Co., Ltd. (located in Beijing Economic and Technological Development Zone) has been committed to the research and development of level sensors and detection technologies for many years, and is a national high-tech enterprise with core technology, integrating production, R&D and sales as one of the intelligent technology solution providers.

The company has four mature technology platforms: magnetostrictive sensor technology platform, rotary encoder technology platform, pressure transmitter technology platform and temperature sensor technology platform. Based on the technology platform and guided by customer needs, the company provides customers with a full range of sensing technology product solutions through professional program design, excellent quality and rapid response ability. The products have also been certified with GB/T19001-2016, CE, UL, ATEX and IECEx certificates, China National Coal mine safety certification, explosion-proof certification, 3C certification etc.

# Example of industrial application— Rubber, Plastic, Tire

**Produce:** With high precision, high reliability and fast response, it can measure the mechanical displacement in real time and accurately, and ensure the quality and dimensional accuracy of rubber and plastic products.

**Maintain:** By monitoring the mechanical displacement value, the operator can find the abnormal situation of the equipment in time, carry out preventive maintenance and avoid the influence of equipment failure on production.

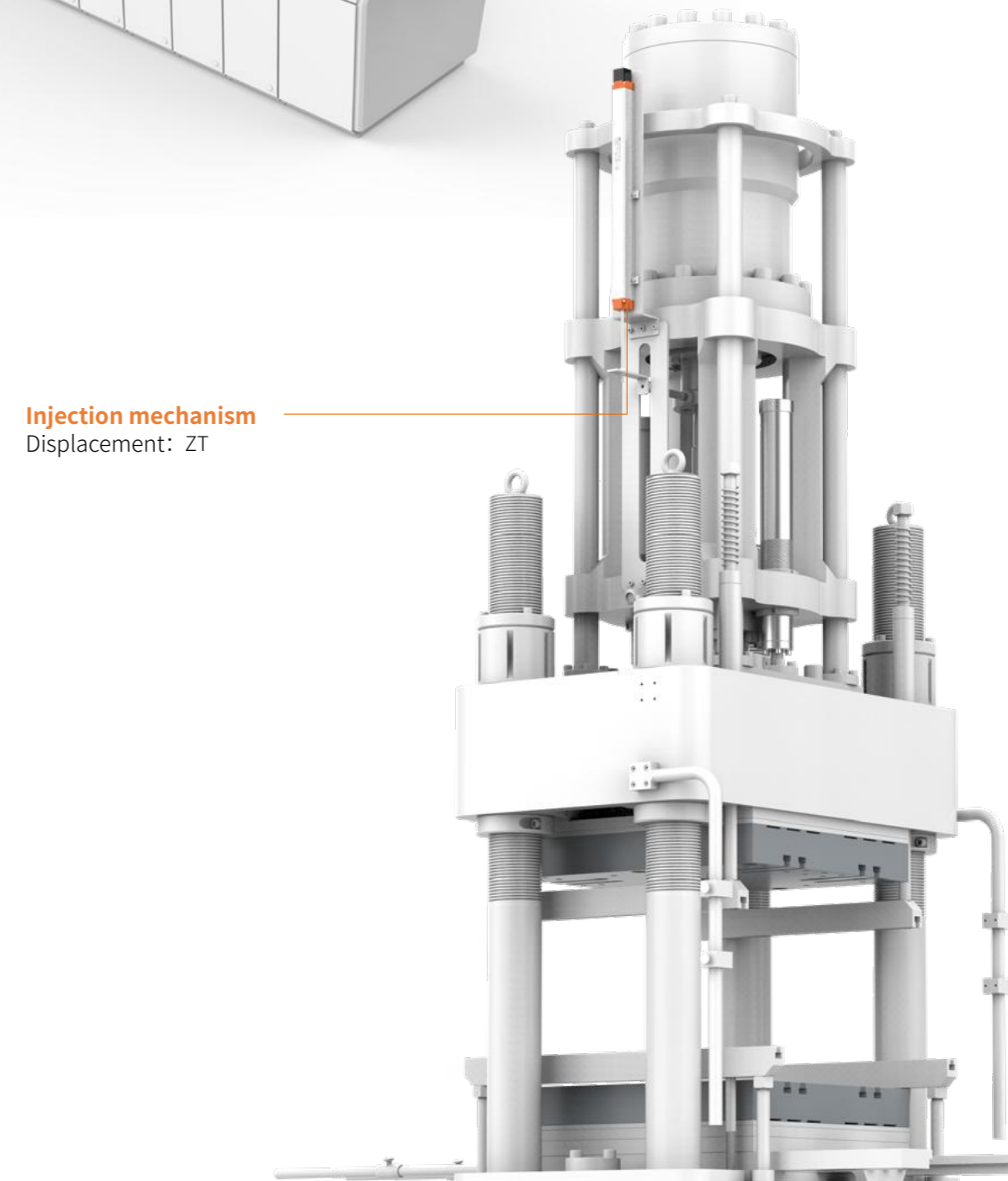
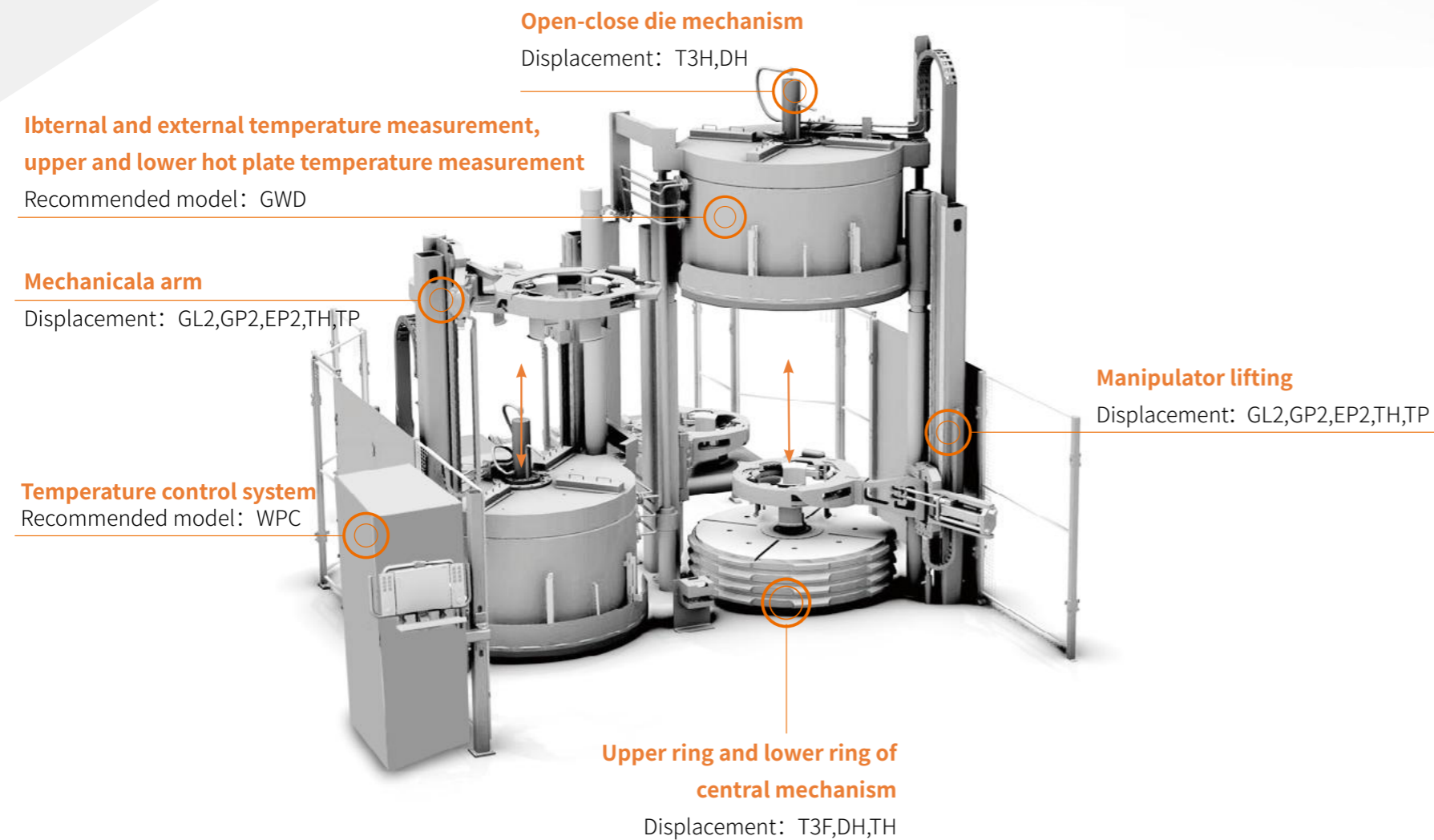
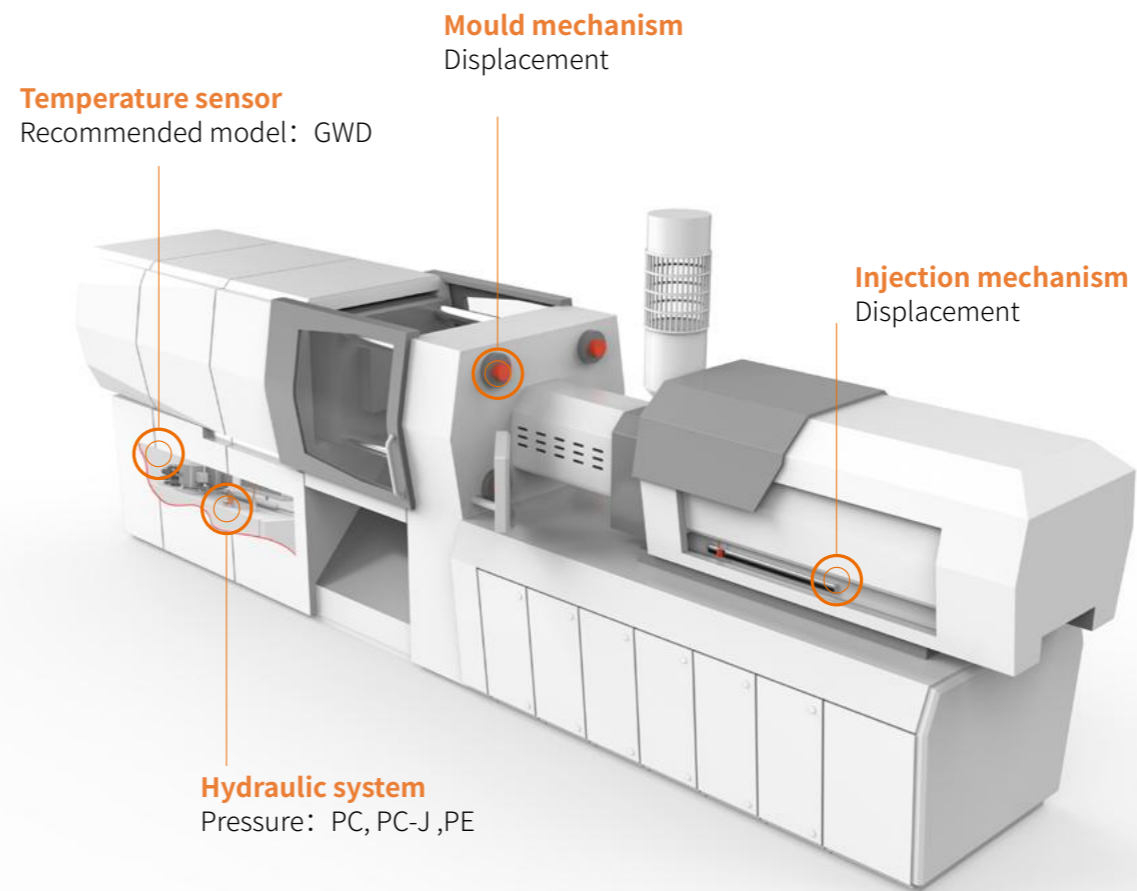

# T-Series

## Magnetostrictive displacement sensor

- + High precision: highest resolution 0.1μm
- + Double anti-interference
- + Resistance to shock and vibration
- + Polarity protection, overvoltage protection
- + Enhanced monitoring and diagnosis functions
- + Wide operating voltage (9VDC~36VDC)

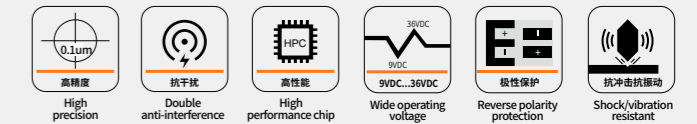

**DH**  
Integrated design, compact size and high cost performance.



**T3H Pressure-resistant outer tube type**  
Threaded installation, suitable for use in hydraulic cylinder or cylinder.



**T3F Flexible outer tube type**  
Flexible outer tube type, with a maximum range of 20 meters, which is convenient for the installation of conveyor (such as the position of central mechanism of vulcanizer.)













**T3P Split type**  
High precision, aluminum shell type, optional floating magnet, U-shaped magnet or slider magnet.

Type	T3H/T3P/T3F	DH
<b>Output</b>	Position, speed	Position, speed
<b>Measuring length</b>	T3H: 25-7650 T3P: 25-5600 T3F: 100-20000	25-5600
<b>Interface type</b>	 	 
<b>Resolution</b>	Analog	16 bit D/A
	SSI	0.1μm
	CANopen	1μm
	Start/Stop	Depending on the controller
	Profibus-DP	1μm
	Profinet	0.5μm
	EtherCAT	0.5μm
EtherNET/IP	1μm	
IO-Link	1μm	
<b>Shock</b>	T3H/T3P : 150 g/11 ms T3F/DH2 : 100 g/6 ms	IEC standard 60068-2-27
<b>Vibration</b>	T3H/T3P: 30 g/10~2000 Hz T3F : 5 g/10~2000 Hz DH2 : 10 g/10~2000 Hz	IEC standard 60068-2-6 (excluding resonance frequency)

## Integral external profile type

### Magnetostrictive displacement sensor

- + Convenient installation,integrated design,no prominent electronic warehouse.
- + Linear measurement,absolute output,no need to return to zero.
- + Application in forgin,building materials,rubber and plactic machinery and other fields.

Type	EP2/GP2/GL2	GR	ZT	ZF
<b>Output</b>	Location、 Speed	Location	Location	Location
<b>Measuring length</b>	50~5600	50~1500	50~2000	50~1500
<b>Interface type</b>	 Analog  SSI  EtherCAT  IO-Link  Start/Stop	 Analog  CANopen  IO-Link	 Analog	 Analog
<b>Resolution</b>	Analog 16 bit D/A	16 bit D/A	12 bit D/A	16 bit D/A
	SSI 0.5μm	--	--	--
	CANopen --	2μm	--	--
	EtherCAT 0.5μm	--	--	--
	IO-Link 1μm	1μm	--	--
<b>Shock</b>	EP2/GP2/GL2/GR : 100 g (Single impact) ZT/ZF : 50 g/6 ms, IEC standard 60068-2-27			
<b>Vibration</b>	EP2/GP2/GL2/GR : 15 g/10~2000 Hz ZT/ZF : 5 g/10~2000 Hz IEC standard 60068-2-6 (excluding resonance frequency)			

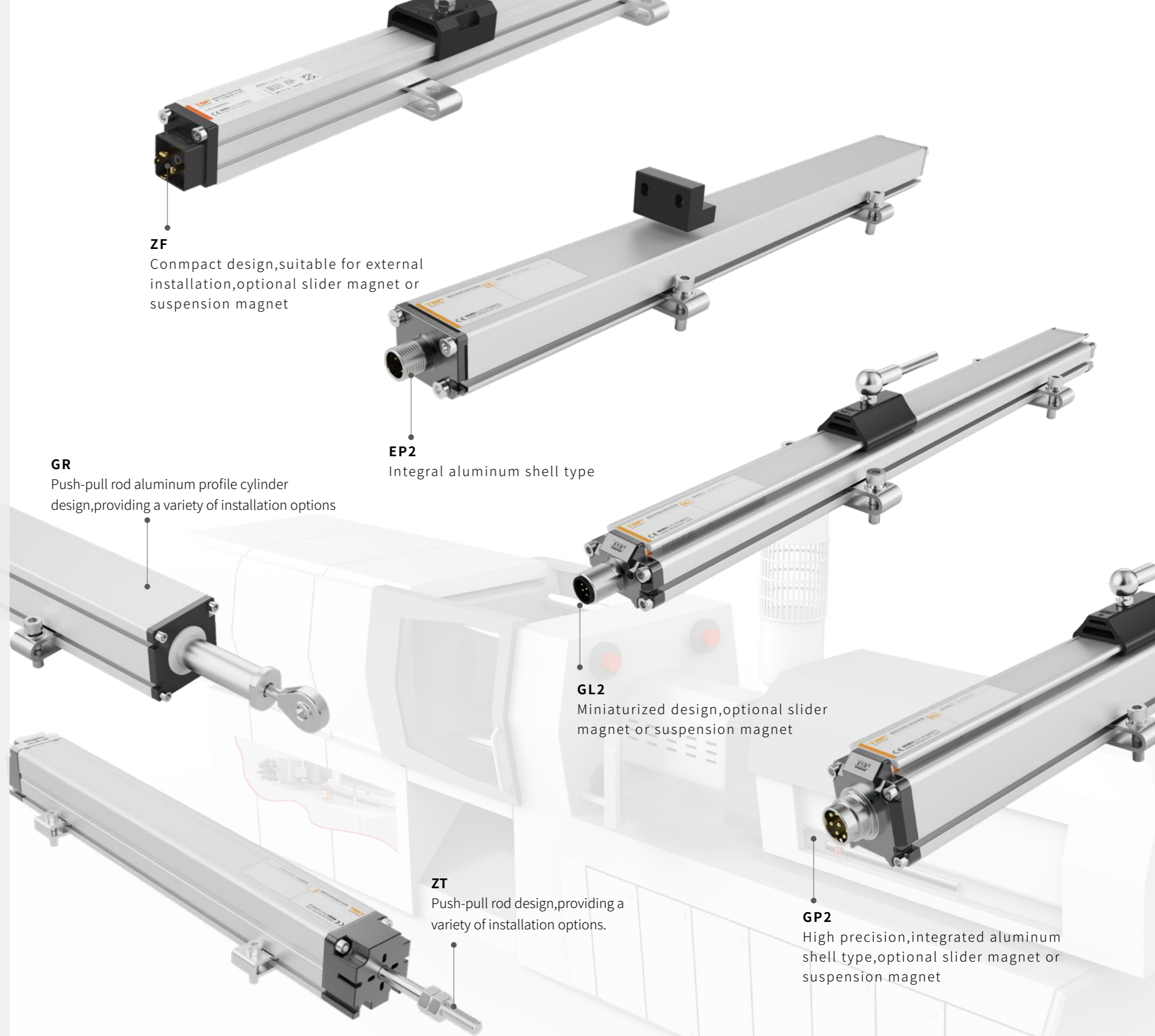

**ZF**  
Compact design,suitable for external installation,optional slider magnet or suspension magnet

**EP2**  
Integral aluminum shell type

**GR**  
Push-pull rod aluminum profile cylinder design,providing a variety of installation options

**GL2**  
Miniaturized design,optional slider magnet or suspension magnet

**ZT**  
Push-pull rod design,providing a variety of installation options.

**GP2**  
High precision,integrated aluminum shell type,optional slider magnet or suspension magnet

# Pressure transmitter series

Pressure transmitter, digital display pressure, pressure switch

Adopting international advanced metal sputtering film pressure core, high-precision silicon pressure core and high-precision silicon flat film core, the equipment has high long-term stability, small temperature drift, wide temperature range, high precision and high pressure impact resistance.



**Machanical pressure switch**

High precision, reliability and durability, and output alarm and control signals.



**Digital pressure transmitter**

The electronic compartment can rotate freely 330°  
Analog+Two-way switch output



**Hessman digital display pressure transmitter**

Adapting hessman connector of pressure transmitter



**PC -type pressure transmitter**

High precision silicon pressure core  
Measuring range:-1~600Bar



**PE -type pressure transmitter**

High precision diffusion silicon flat film core  
Measuring range:-1~400Bar



**PC-J-type pressure transmitter**

Metal sputtering film pressure core, compact design, small size  
Measuring range:5~600Bar



Type	PC-J	PE	PC
Pressure core	Metal sputtering film	Diffused silicon flat film	Diffused silicon
Measuring range	5~600Bar	-1~400Bar	-1~600Bar
Pressure Type	Manometer pressure	Gauge pressure and absolute pressure	Gauge pressure, absolute pressure and sealed gauge pressure



Type	PC-D	PC-T / PE-T	PC / PE / PC-J
Name	Machanical pressure switch	Digital pressure transmitter	Hessman digital display pressure transmitter
Explain	When measuring the pressure value, the user can adjust it at will within the measuring range. Adjust the measured pressure by rotating the pressure regulating thumbwheel. After the pressure regulation is completed, the thumbwheel can be fixed to prevent the pressure from changing during use.	Digital display pressure transmitter with integrated display; The electronic compartment can rotate freely by 330 degrees.	Adapted to hessman connector of pressure sensor, it can set pressure unit, zero/full position correction point, upper/lower range and other functions.

# Temperature Series

Temperature sensor/Transmitter/Switch  
Liquid level temperature sensor

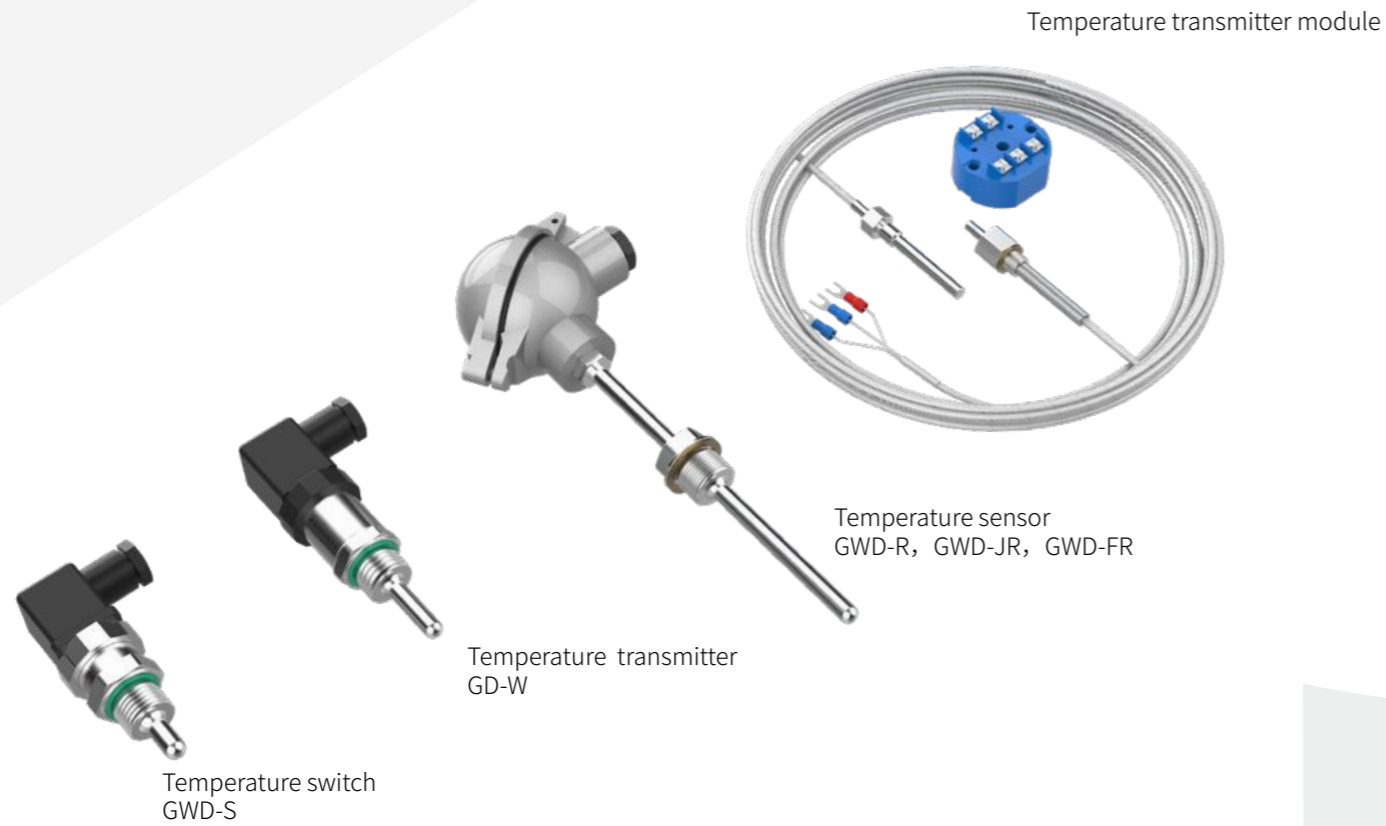

<b>Temperature measuring range</b>	-50~300°C ( normal -50~250°C)					
<b>Graduation number/resistance value</b>		The standard resistance value R at 0°C		The standard resistance value R at 100°C		
	PT100	100.00		138.51		
	PT1000	1000.00		1385.1		
<b>Measurement Error</b>	Grade	Error of resistance at zero degree%			Temperature error °C	
	A	±0.06			± (0.15+0.002  t )	
	B	±0.12			± (0.30+0.005  t )	
<b>Response time</b>	Rod diameter mm	5	6	8	10	12
	Thermal response time s (T0.5)	≤ 8	≤ 15	≤ 30	≤ 30	≤ 30

# Liquid level temperature series

—Precise monitoring of liquid level and temperature, stable and reliable.

The float-type liquid level temperature sensor adopts the integrated design of float and temperature probe, which can measure liquid level height and liquid temperature at the same time, and has the characteristics of simple structure, corrosion resistance, strong antiinterference and long service life.



Type	LH-YT	YW
Liquid level range	40...2000mm	50...4500mm
Temperature range	-40...125°C	-40...125°C
Output	4 channels of NPN/PNP+2 channels of analog signals	Analog, CANopen

# Rotary encoder

## Compact, Standard, Bus, Heavy-duty

Factory automation involves a number of coordinated manufacturing procedures performed at various production stages. TBF encoder is used to ensure the correct position, speed, angle or other manufacturing process requirements. It is connected with automatic control through industry standard protocol, which is convenient for real-time monitoring and adjusting the state of components, thus improving work efficiency.



**Standard Encoder  
BNMA58**

Diameter: 58mm  
Single lap resolution: 8...16bit  
Number of pturns: < 24bit  
Interface: SSI/SSI+increment  
CANopen/CANopen+increment



**Networked Encoder  
BNMA58**

Diameter: 58mm  
Single lap resolution: 8...16bit  
Number of pturns: < 24bit  
Interface: Profinet



**Standard Encoder  
BNTI58**

Diameter: 58mm  
Resolution: 5000PPR  
Output: TTL/HTL



**Compact  
BNMA36**

Diameter: 36mm  
Single lap resolution: 12...16bit  
Number of pturns: < 20bit  
Interface: SSI, SSI+increment  
CANopen

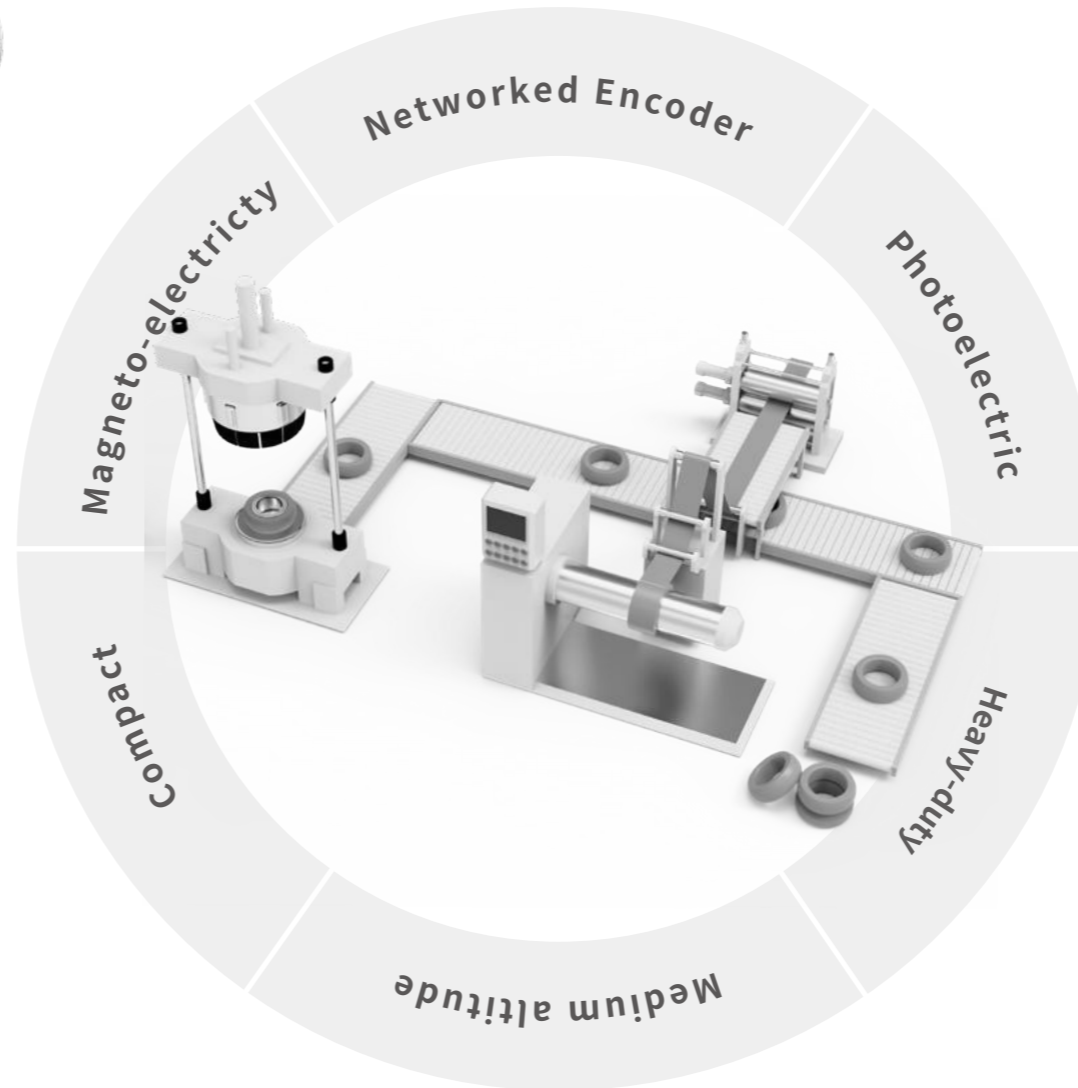

**Heavy-duty Encoder  
BNTI100 Photoelectric  
increment**

Diameter: 99mm  
Resolution: 1024/5000PPR  
Output: TTL/HTL



**Hollow Shaft Encoder  
BNTI99 Photoelectric increment**

Diameter: 99mm  
Resolution: 1024/5000PPR  
Output: TTL/HTL

# WPC Power controllers

- + It communicates with the host computer through Ethernet port, RS485 and other interfaces.
- + Human-friendly interaction is achieved through the indication of OLED LCD screen and LED light.
- + Multi-channel signal input design, current signal, voltage signal, platinum resistance signal input can be.
- + A variety of control methods: constant voltage, constant current, constant power, open loop, frequency control.
- + Multiple protection functions: phase loss, overcurrent, overtemperature, disconnection protection, module breakdown alarm.
- + It can communicate with the PC through the USB port to realize parameter setting.

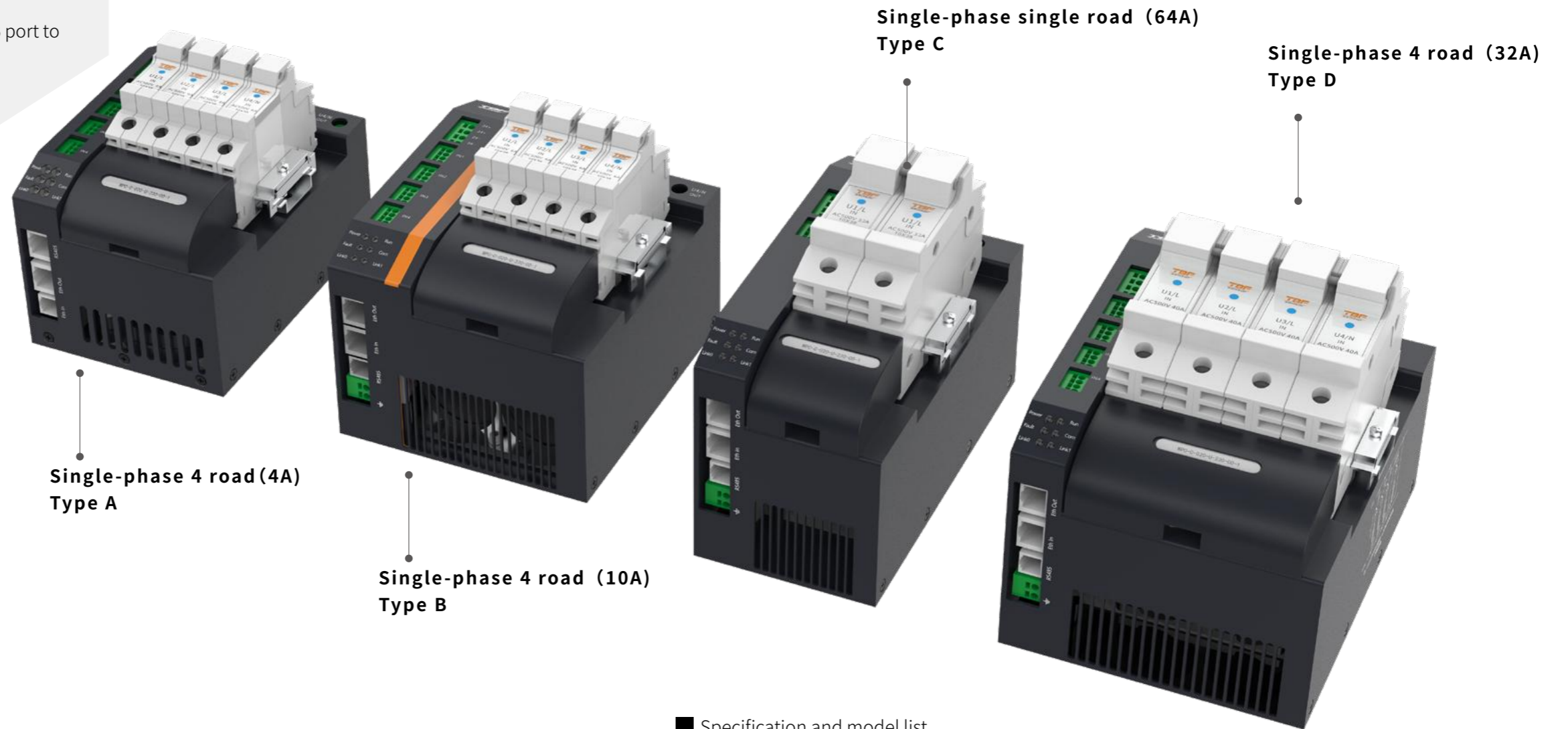

■ Specification and model list





Specifications and models	Circuit	Type	Measure (mm)			Fix	Rated power (kW)	Rated current (A)	Rated voltageAC (V)	Dissipate heat
			Length	Width	Height					
WPC-D-004-Z-230-EC-1	single-phase 4 road	A	160	106	136	DIN35	4	4	230	Natural cooling
WPC-D-010-Z-230-EC-1	single-phase 4 road	B	160	128	136	DIN35	10	10	230	Air blast cooling
WPC-D-032-Z-230-EC-1	single-phase 4 road	D	160	128	136	DIN35	30	32	230	Air blast cooling
WPC-D-010-Z-380-EC-1	single-phase 4 road	B	160	128	136	DIN35	16	10	380	Air blast cooling
WPC-A-050-Z-230-EC-1	single-phase single road	C	189	88	164	DIN35	11	50	230	Air blast cooling





# Product overview

## T Plastic, rubber and tires

For more information, please contact TBF

### Position detection

Basic information	T3H	T3P	T3F	DH
Position, speed measurement range: 25...7650mm	Position, speed measurement range: 25...5600mm	Position, speed measurement range: 100...20000mm	Position, speed measurement range: 25...5600mm	
Application	Measure the mold clamping and stroke movement, and the position of core-pulling mechanism; Detect that positions of the upper ring and the lower ring of the central mechanism, and the real-time positions of the open-close die and the movable die, Mechanical arm position detection, etc.			
接口类型				
				
Authentication	CE, UL	CE, UL	CE, UL	CE, UL

Basic information	EP2/GP2/GL2	ZT	GR	ZF
Position, speed Range: 50...5600mm	Position Range: 50...2000mm	Position Range: 50...1500mm	Position Range: 50...1500mm	
Application	Measure the movement of the manipulator, open and close the real-time position of the mold, and detect the movement of the injection axis.			
Interface type				
				
Authentication	CE	CE	CE	CE

### Pressure detection

Basic information	PC-J Series	PE Series	PC Series	PC-T Series	Mechanical pressure switch	PC/PE/PC-J
Metal sputtering film 5~600Bar	Diffused silicon flat film -1~400Bar	Diffused silicon -1~600Bar	With integrated digital display -1~600Bar	Adjustable extent (Mpa) 0.014~12.4	Hessman digital display pressure transmitter	
Application	Monitor the pressure on the hydraulic power unit and monitor the pressure in the vulcanizer					
Output	Current/voltage signal	Simulation current/voltage signal, RS485	Simulation current/voltage signal	Simulation current/voltage signal	SPDT	/
Pressure type	Gauge pressure	Gauge pressure, absolute pressure	Gauge pressure, absolute pressure and sealed gauge pressure	Gauge pressure, absolute pressure and sealed gauge pressure	/	Gauge pressure, absolute pressure and sealed gauge pressure

### Temperature detection

Basic information	GWD-R/FR/JR	GD-W	GWD-S	LH-YT	YW/YW+digital display
-50~250°C -50~300°C	Temperature transmitter -20~120°C	Temperature switch 0~100°C	-40~125°C 40...2000mm	-40~125°C 50...4500mm	
Output	Resistance signal	4...20mA	SPST	Analog	Analog
Application	Thermal pipeline, vulcanizing machine liquid or gas, hot plate temperature measurement, hydraulic station temperature detection				
Resistance model	PT100 A class, PT100 B class, PT1000 A class, PT1000 B class				

### Rotation measurement

Basic information	BNMA36	BNMA58	BNTI99/BNTI100/BNTI58	Servo encoder	Servo encoder (Increment)
Absolute value absolute value+increment	Absolute value absolute value+increment	Increment	Absolute value	Increment	
Application	Automatic control and angle measurement of production line			Electric vulcanizer, servo motor	

### Power control

Basic information	<b>WPC power controller</b> Current 10~32A
Application	By controlling the output power, the output power of the heating equipment is adjusted
Control model	U, U <sup>2</sup> /I, I <sup>2</sup> /Power P/Phase constant work/Frequency zero-crossing power adjustment/Fixed period zero-crossing power regulation
Protocol	RS485, PROFINET, EtherCAT, EtherNET, Modbus
Circuit	Single-phase single path, Single-phase double circuit, Single-phase 4 road



Beijing Tebeifu Electronic Technology Co., Ltd.  
Building 6, Dazhu Enterprise Bay,  
8th yard of Liangshuihe 2nd street, BDA P.R.China  
Tel: +86 10-67948976/67948916  
Fax:+86 10-67948979  
Mailbox: sale@tbfsensor.com  
Web: www.tbfsensor.com

---

TBF Electronic Technology GmbH(German branch )  
Felix-Wankel-Str.1, 85221 Dachau, Germany  
Tel: +49 (0) 8131 337578-0  
E-mail: info@tbfsensor.de  
Web: en.tbfsensor.com

Website



Wechat

