

## Hazardous environment

Explosion-proof sensor Selection guide

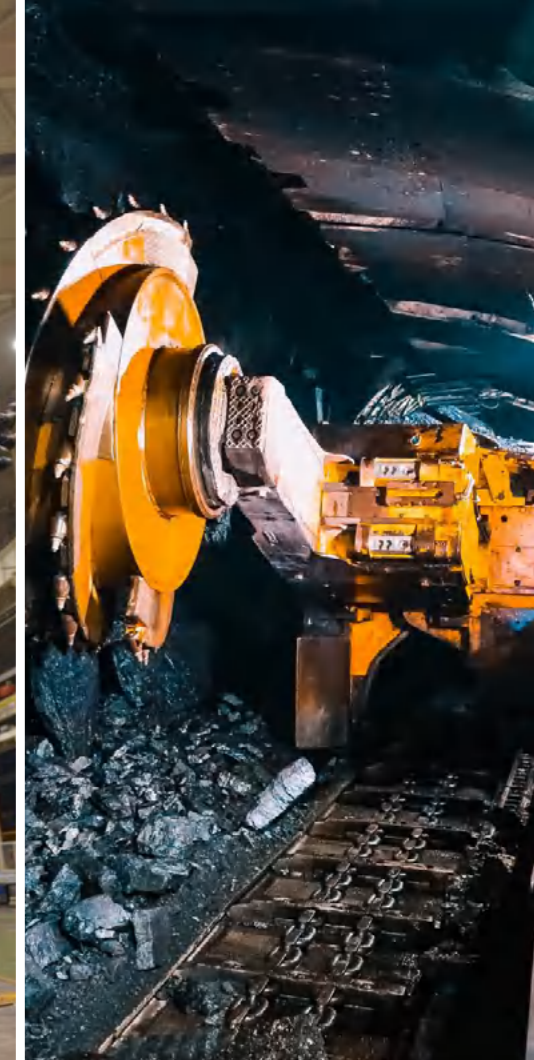

This sample only includes some TBF's products,for more information,please contact us !

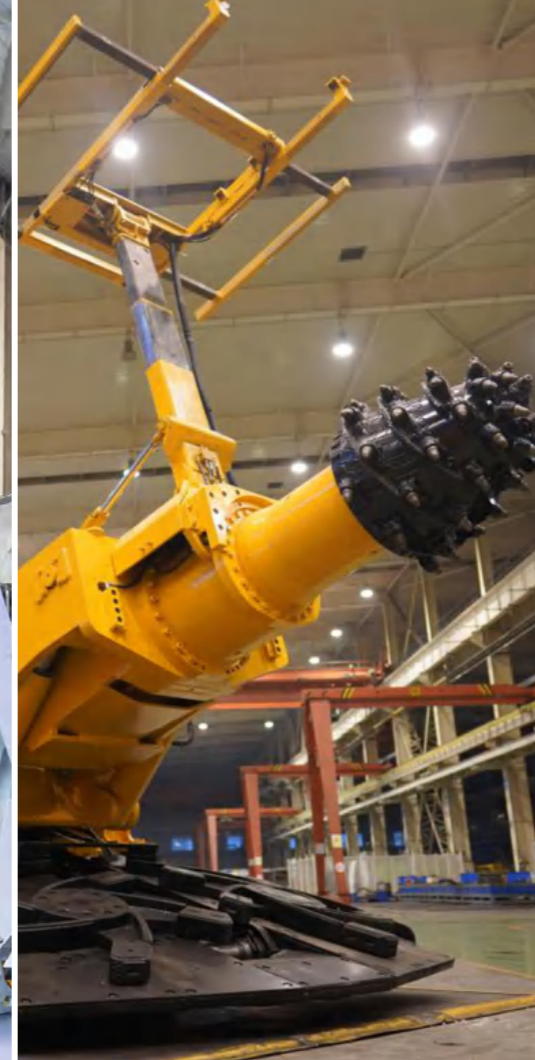

## Beijing Tebeifu Electronic Technology Co., Ltd.



Beijing Tebeifu Electronic Technology Co., Ltd. (located in Beijing Economic and Technological Development Zone) has been committed to the research and development of level sensors and detection technologies for many years, and is a national high-tech enterprise with core technology, integrating production, R&D and sales as one of the intelligent technology solution providers.

The company has four mature technology platforms: magnetostrictive sensor technology platform, rotary encoder technology platform, pressure transmitter technology platform and temperature sensor technology platform. Based on the technology platform and guided by customer needs, the company provides customers with a full range of sensing technology product solutions through professional program design, excellent quality and rapid response ability. The products have also been certified with GB/T19001-2016, CE, UL, ATEX and IECEx certificates, China National Coal mine safety certification, explosion-proof certification, 3C certification etc.

Products are widely used in rubber and plastics, metallurgy, coking, construction machinery, maritime, coal mines, water conservancy, military industry, petroleum and petrochemical, environmental protection, clean energy and other fields.



# Magnetostrictive displacement sensor

**High-precision:** Can provide accurate displacement measurement.

**High-reliability:** Can still work stably in harsh environment.

**Long life:** Durable and not easily damaged.

**Contactless measurement:** Avoid mechanical wear and interference.

## The concrete function in mine hydraulic support:

### Real-time monitoring of bracket displacement:

Accurately understand the telescopic syaye of the support to ensure the supporting effect

### Early warning and protection:

Find abnormal displacement in time,give early warning and take coiesponding measures to prevent accidents caused by support failure.

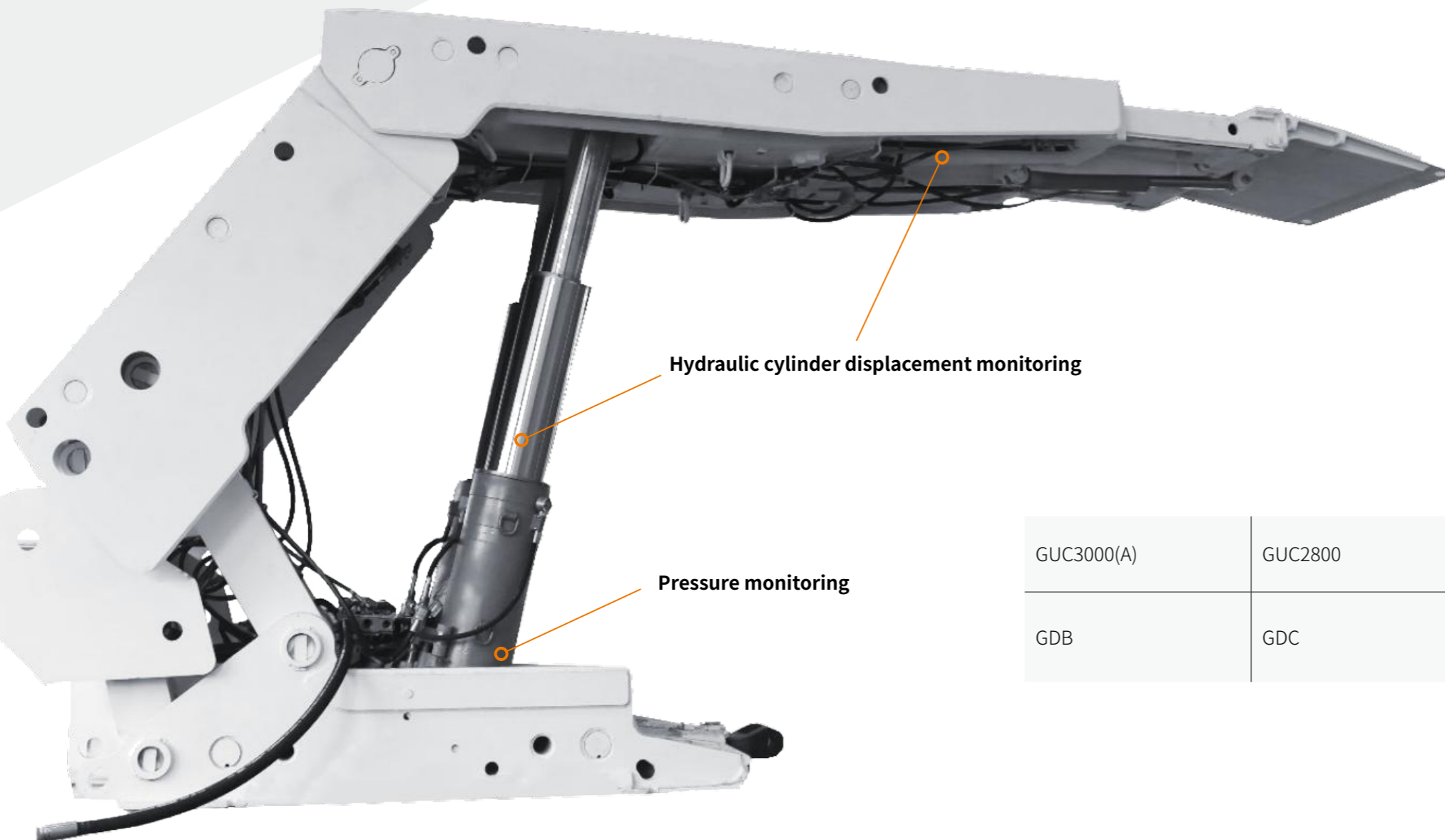

GUC3000(A)	GUC2800	GUC2500 GUC2500 (A)	GUC1800(B)	GUC2400 GUC1200(C)
GDB	GDC	GDM Straight out type	GDM Side-out type	CHR

# Magnetostrictive displacement sensor

Magnetostrictive sensors play a key role in intelligent upgrading of mines, especially in unmanned mining, safety detection and other scenes.

With its stability and long service life, it becomes a key component, especially suitable for working conditions with large vibration and poor environment.

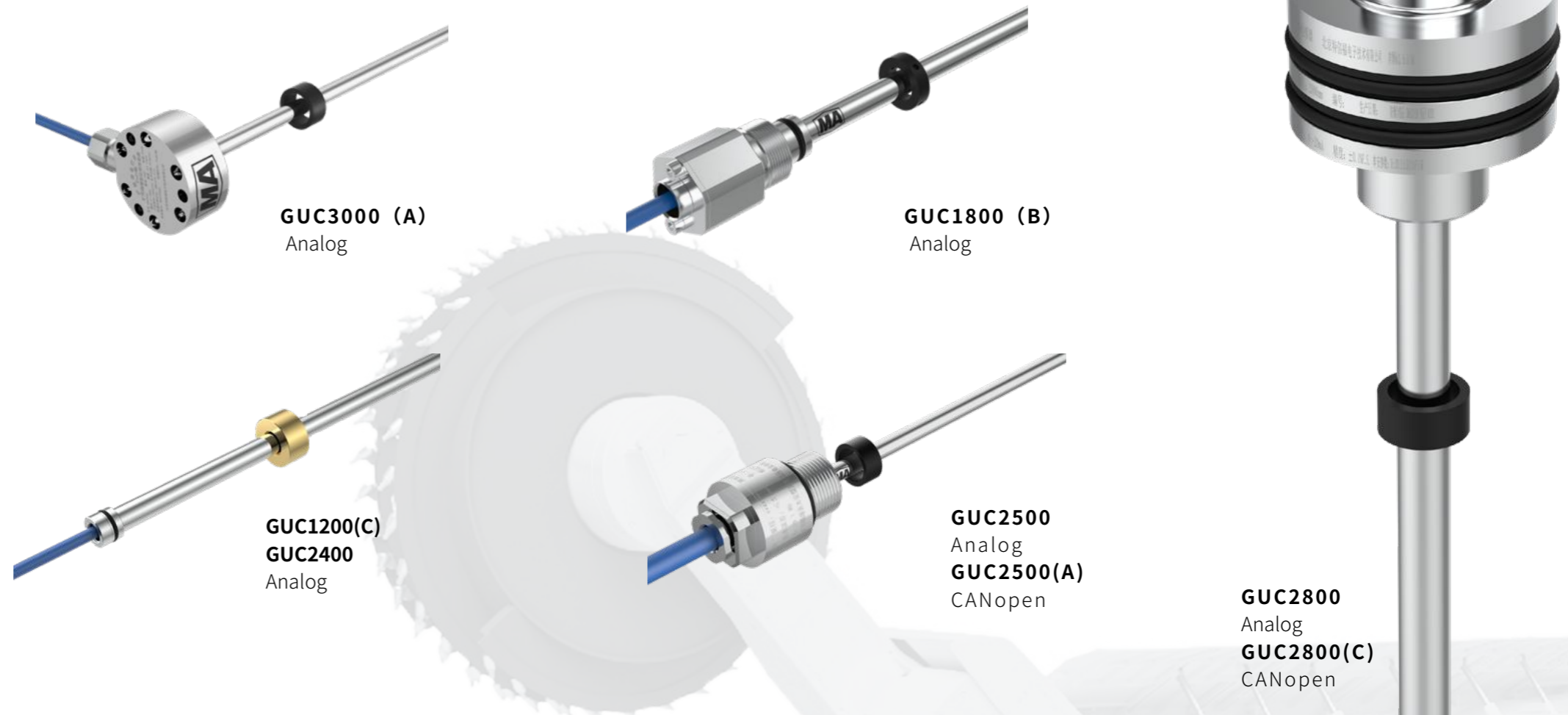

Model	GUC3000(A)	GUC2800 GUC2800(C)	GUC2500 GUC2500 (A)	GUC1800(B)	GUC2400 GUC1200(C)
Category	Mine flameproof type Ex db I Mb  Flameproof shell, flange installation, high protection level, suitable for flameproof places	Mine intrinsically safe type Ex ib I Mb  Embedded installation, does not occupy external space, high precision and good stability	Mine intrinsically safe type Ex ib I Mb  Thread form, quick installation, small electronic, warehouse, suitable for small oil cylinders and compact environment	Mine intrinsically safe type Ex ib I Mb  Flexible design, can pull core without pressure relief, convenient and flexible	Mine intrinsically safe type Ex ib I Mb  Small size, embedded, suitable for hydraulic cylinders with limited space
Measuring length	50-3000mm	50-2800mm	50-2500mm	50-2400mm	50-2400mm
Output signal type	4-20mA; 0-10VDC	4-20mA; 0-10VDC CANopen	4-20mA, 0-10VDC CANopen	4-20mA; 0.25-4.75VDC; 0.5-4.5VDC; 4.5-0.5VDC	0.5-4.5VDC; 0.7-3.55VDC
Output information	Position	Position	Position	Position	Position

# Magnetostrictive displacement sensor

This product conforms to GB/T 3836.1-2021 General Requirements for Electrical Equipment in Explosive Gas Environments Part 1 Equipment GB/T 3836.2-2021 Electrical Equipment in Explosive Gas Environments Part 2 Equipment Protected by Flameproof Enclosure "d". The explosion-proof mark is Ex db IIC T5 Gb, which is suitable for the formation of combustible gas or steam containing Class II A, B and C T1-T5 groups and air. It is mainly used in high-risk industries such as petroleum, chemical industry and natural gas. The existence of explosive gas or dust makes the explosion-proof design of equipment a top priority in safety production.

CHR Straight out type





CHR Side-out type

GDB

GDC

GDM Straight out type

GDM Side-out type

EX explosion proof type	GDB 	GDC 	GDM 	CHR 
Category	explosion proof type Pressure-resistant outer tube, high protection level, used in potential explosive environment, obtained IECEx, ATEX international certification			explosion proof type
Domestic certification	WEx d IIB T5 Gb	Ex d IIC T5 Gb	Ex d IIC T5 Gb	Ex db IIC T5 Gb
International certification	EU certification I M2 Ex db I Mb, II 2G Ex db IIC T5 Gb international certification Ex db I Mb, Ex db IIC T5 Gb			
Measuring length	50~4500mm			50~4500mm
Output signal type	4~20mA; 20~4mA; 0~20mA; 20~0mA; 0~10VDC; 10~0VDC; 0~5VDC; 5~0VDC			



# Explosion-proof encoder

Explosion-proof encoders have the following common application scenarios:

**Lifting system:** Used to accurately measure the position and speed of the lifting container

**Conveyor belt system:** Monitor the running position and speed of the conveyor belt

**Shearer control:** Assist in controlling the operation and positioning of shearer

**Underground transportation equipment:** Monitor the position and status of various transportation equipment

**Safety monitoring:** Provide location information in some security systems

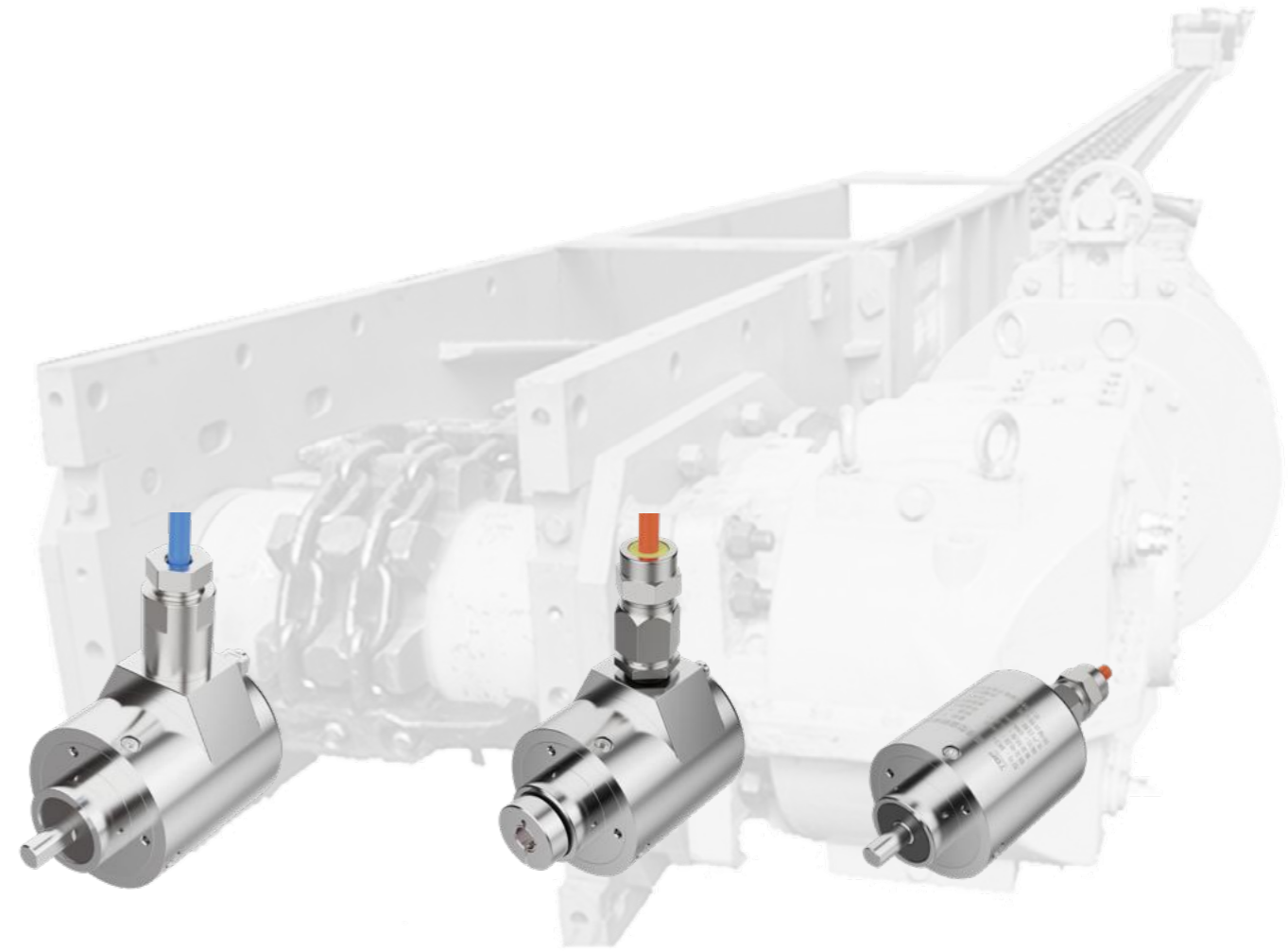

Model	BQH12 Mine intrinsically safe type
Certification	Ex id I Mb
Outside diameter of product	φ58mm
Measurement data	Angle、 speed
Operating voltage	12±10%V DC
Working temperature	-40°C ~+85°C
Repeatability	≤ 0.1°
Speed accuracy	0.5%F.S.
Axis type	Solid axle
Rotation speed	0~3000r/min
Protection grades	Shell: IP65;Axle: IP54
Output signal	CANopen
Single lap resolution	12~14bit
Number of pturns	12bit (4096)



Model	BQB24 Mine flameproof type
Certification	Ex d I Mb
Outside diameter of product	φ70mm
Measurement data	Angle、 speed
Operating voltage	10~30V DC
Working temperature	-40°C ~+85°C
Repeatability	≤ 0.1°
Speed accuracy	0.5%F.S.
Axis type	Solid axle
Rotation speed	0~3000r/min
Protection grades	IP67
Output signal	CANopen
Single lap resolution	12~14bit
Number of pturns	12bit (4096)



Model	BK24 (II C Flameproof type)
Certification	Ex db IIC T5 Gb
Outside diameter of product	φ70mm
Measurement data	Angle、 speed
Operating voltage	10~30V DC
Working temperature	-40°C ~+85°C
Repeatability	≤ 0.1°
Speed accuracy	0.5%F.S.
Axis type	Solid axle /blind hole shaft
Rotation speed	0~3000r/min
Protection grades	IP67
Output signal	CANopen
Single lap resolution	12~14bit
Number of pturns	12bit (4096)

# Mine pressure sensor

Mine pressure sensor have the following common application scenarios:

**Mine ventilation system:** Monitor the wind pressure in the mine to ensure normal ventilation

**Mining face:** Measuring the working pressure of mining machinery

**Hydraulic pressure system:** Monitor the pressure state of hydraulic equipment

**Mine drainage system:** Measure the pressure in the drainage pipe

**Mine transportation system:** Used for pressure monitoring of transportation equipment such as conveyor belt

**Mine safety monitoring:** Assist in monitoring various pressure parameters in the mine to ensure safe production



<b>Model</b>	<b>GPD Series mine flameproof type</b>
<b>Measurement data</b>	Pressure
<b>Measuring range</b>	40~600Bar
<b>Output signal</b>	Current: 4mA ~ 20mA voltage: 1~5V; 0~5V; 0~10V
<b>Pressure type</b>	Gauge pressure, absolute pressure and sealed gauge pressure
<b>Overload pressure</b>	150%F.S.
<b>Measurement accuracy</b>	±0.5%F.S.
<b>Explosion-proof sign</b>	Ex II 2 G Ex db II C T5 Gb



Model	GPD60 Mine flameproof type	GPD60 (B) Mine flameproof type	GPD60 (C) Mine intrinsically safe type	PT Mine flameproof type	GPD70 Mine flameproof type
<b>Measurement data</b>	Pressure	Pressure	Pressure	Pressure, temperature	Pressure, temperature
<b>Measuring range</b>	0~600Bar	0~10Bar	0~600Bar	Pressure: 0~0.6MPa、0~1.0MPa、 -0.1~1.0MPa、-0.1~4.0MPa temperature: -30°C ~100°C	0~700Bar
<b>Output signal</b>	Current: 4mA ~ 20mA voltage: 1~5V; 0~5V; 0~10V	Current: 4mA ~ 20mA voltage: 0~10V	Voltage: 0.5~4.5V; 0~5V; 0~10V	Pressure: 4~20mA; 0~5V; 0~10V temperature: 4~20mA; 0~5V; 0~10V	CAN2.0
<b>Pressure type</b>	Gauge pressure, absolute pressure and sealed gauge pressure	Gauge pressure, absolute pressure	Gauge pressure, absolute pressure and sealed gauge pressure	Gauge pressure, absolute pressure	Gauge pressure, absolute pressure and sealed gauge pressure
<b>Overload pressure</b>	150%F.S.	150%F.S.	150%F.S.	200%F.S.	150%F.S.
<b>Measurement accuracy</b>	±0.5%F.S.	±0.5%F.S.	±0.5%F.S.	±0.5%F.S.	±0.5%F.S.
<b>Explosion-proof sign</b>	Ex d I Mb	Ex d I Mb	Ex ib I Mb	Ex d I Mb	Ex db I Mb

# Explosion-proof liquid level temperature sensor

## Technical parameter



Mine flameproof type		
Model	GWYS3000/100	GYW3000/130
Measurement data	Liquid level temperature	Liquid level temperature
Output	Analog/ CANopen	Analog
Liquid level measuring range	50~3000mm	
Temperature measuring range	0~100°C	0~130°C
Explosion-proof sign	Ex db I Mb	



Flameproof type		
Model	GWY	GWYC
Measurement data	Liquid level temperature	Liquid level temperature
Output	Analog	Analog
Liqui level measuring range	50~3000mm	50~4500mm
Temperature measuring range	-45~130°C	-40~125°C
Explosion-proof sign	Ex db IIC T5 Gb	



Flameproof type	
Model	GYD
Measurement data	Liquid level
Output	Analog
Liqui level measuring range	50~4500mm
Explosion-proof sign	Ex II 2G Ex db IIC Gb

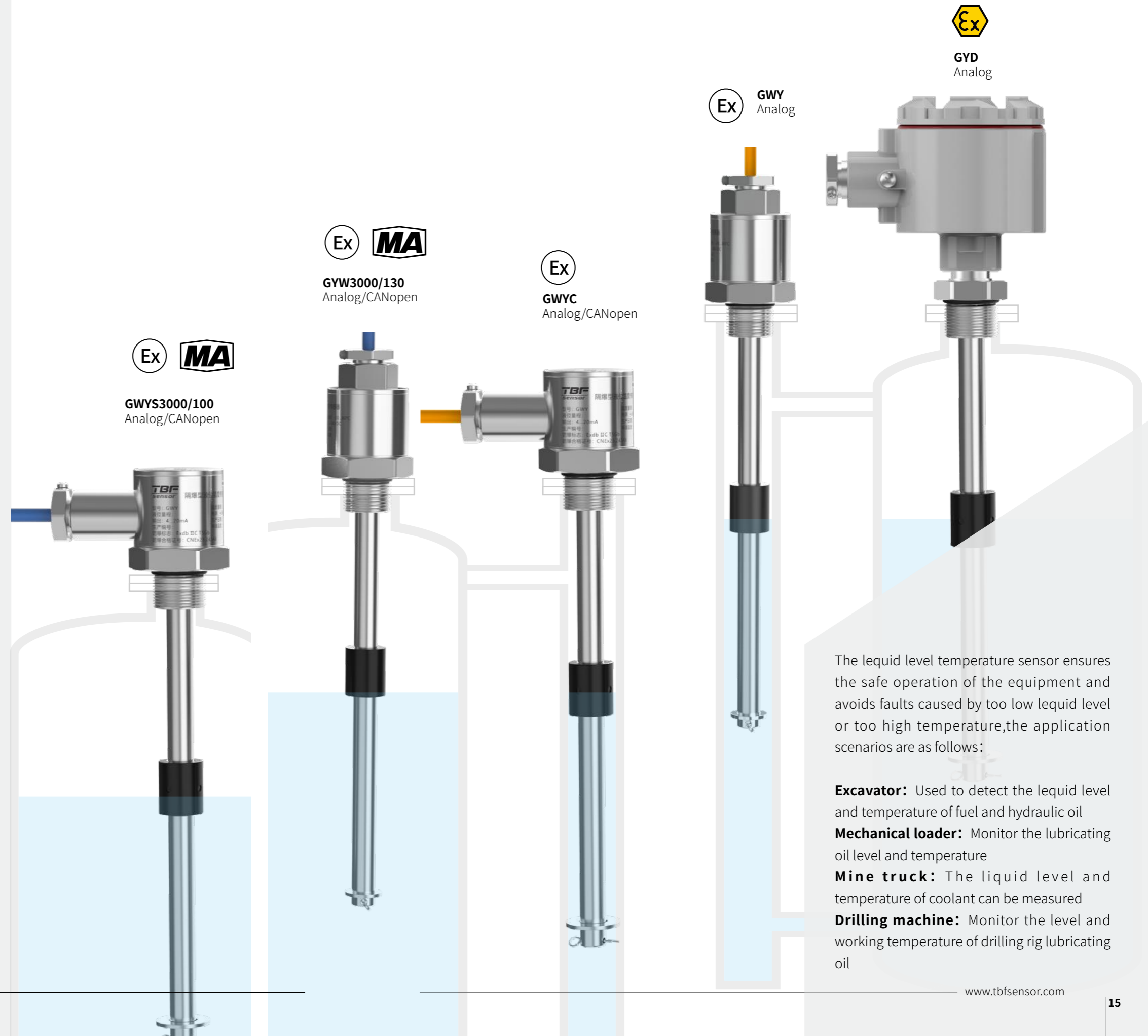

The liquid level temperature sensor ensures the safe operation of the equipment and avoids faults caused by too low liquid level or too high temperature, the application scenarios are as follows:

- Excavator:** Used to detect the liquid level and temperature of fuel and hydraulic oil
- Mechanical loader:** Monitor the lubricating oil level and temperature
- Mine truck:** The liquid level and temperature of coolant can be measured
- Drilling machine:** Monitor the level and working temperature of drilling rig lubricating oil

## Other sensors

### Temperature sensor:

Flameproof temperature sensor (GWD) adopts PT100 platinum resistor, which can accurately measure the temperature.

### Draw wire sensor

Travel monitoring and control of hydraulic support; Location and travel of shearer; Belt conveyor correction and tension monitoring; Gate and air door opening control; Position monitoring of hoist and winch container; Convergence monitoring of roadway surface displacement.





































Model	RC126 Flameproof type
Measurement data	Position
Measuring range	0~10m
Output signal	Current: 4mA ~ 20mA voltage: 0~5V
Linearity	≤ 0.4%F.S.
Export tension	5~15N
Working speed	≤ 1m/s
Explosion-proof sign	Ex db II C T5 Gb











Model	GWD Series flameproof type	GWD120 Mine flameproof type
Measurement data	Temperature	Temperature
Measuring range	0~120°C	0~120°C
Output signal	Current: 4mA ~ 20mA voltage: 0~10V	Current: 4mA ~ 20mA voltage: 0~10V
Maximum transmission distance	10m	10m
Measurement accuracy	±2.5%F.S.	±2.5%F.S.
Long term stability	±0.3%F.S./year	±0.3%F.S./year
Explosion-proof sign	Ex II 2 G Ex db II C T5 Gb	Ex db I Mb



















 Magnetostriuctive displacement sensor

Displacement sensor	Model	Measuring range	Certification
	GUC3000(A) Mine flameproof type	50-3000mm	Ex db I Mb  
	GUC2800 GUC2800(C) Mine intrinsically safe type	50-2800mm	Ex ib I Mb  
	GUC2500 GUC2500(A) Mine intrinsically safe type	50-2500mm	Ex ib I Mb  
	GUC1800(B) Mine intrinsically safe type	50-2400mm	Ex ib I Mb  
	GUC2400 GUC1200(C) Mine intrinsically safe type	50-2400mm	Ex ib I Mb  
	GDB Flameproof type	50-4500mm	Ex d IIB T5 Gb     
	GDC Flameproof type	50-4500mm	Ex d IIC T5 Gb     
	GDM Flameproof type	50-4500mm	Ex d IIC T5 Gb     
	CHR Flameproof type	50-4500mm	Ex db IIC T5 Gb 





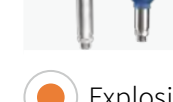







 Explosion-proof encoder

Rotary encoder	Model	Output	Certification
	BQH12 Mine intrinsically safe type	CANopen	Ex id I Mb  
	BQB24 Mine flameproof type	CANopen	Ex d I Mb  
	BK24 (II C Flameproof type)	CANopen	Ex db IIC T5 Gb 







 Mine pressure sensor

Pressure series	Model	Measuring range	Certification
	GPD60 Mine flameproof type	0~600Bar	Ex d I Mb  
	GPD60 (B) Mine flameproof type	0~10Bar	Ex d I Mb  
	GPD60 (C) Mine intrinsically safe type	0~600Bar	Ex ib I Mb  
	PT Mine flameproof type	pressure: 0~0.6MPa、0~1.0MPa -0.1~1.0MPa、-0.1~4.0MPa temperature: -30°C ~100°C	Ex d I Mb  
	GPD70 Mine flameproof type	0~700Bar	Ex db I Mb  
	GPD Series Flameproof type	40~600Bar	 II 2 G Ex db II C T5 Gb

 Explosion-proof liquid level temperature sensor

Liquid, gas	Model	Measuring range	Certification
	GWYS3000/100 Mine flameproof type	50~3000mm	Ex db I Mb  
	GYW3000/130 Mine flameproof type	50~3000mm	Ex db I Mb  
	GWY Flameproof type	50~3000mm	Ex db IIC T5 Gb 
	GWYC Flameproof type	50~4500mm	Ex db IIC T5 Gb 
	GYD Flameproof type	50~4500mm	 II 2G Ex db IIC Gb

 Other sensors

Other sensors	Model	Measuring range	Certification
	RC126 Flameproof type Draw wire sensor	0~10m	Ex db II C T5 Gb 
	GWD Series Flameproof type Temperature sensor	0~120°C	 II 2 G Ex db II C T5 Gb
	GWD Series Intrinsically safe type Temperature sensor	0~120°C	Ex db I Mb  



Beijing Tebeifu Electronic Technology Co., Ltd.  
Building 6, Dazhu Enterprise Bay,  
8th yard of Liangshuihe 2nd street, BDA P.R.China  
Tel: +86 10-67948976/67948916  
Fax:+86 10-67948979  
Mailbox: sale@tbfsensor.com  
Web: www.tbfsensor.com

---

TBF Electronic Technology GmbH(German branch )  
Felix-Wankel-Str.1, 85221 Dachau, Germany  
Tel: +49 (0) 8131 337578-0  
E-mail: info@tbfsensor.de  
Web: en.tbfsensor.com

Website



Wechat

